

# Xenus™ Regeneration Guide



P/N 95-00306-000

Revision 3  
June 2008

## Xenus Regeneration Guide

This page for notes.

# TABLE OF CONTENTS

<b>About This Guide</b> .....	<b>iii</b>
Overview and Scope.....	iii
Related Documentation.....	iii
Comments.....	iii
Copyrights.....	iii
Document Validity.....	iii
Product Warnings.....	iv
Revision History.....	iv
<b>1: Regen Resistors for Xenus</b> .....	<b>1</b>
1.1: Regen Resistor Theory.....	2
1.2: Amplifier Regen Circuit Output Specifications.....	3
1.3: Copley Standard Regen Resistors.....	4
1.3.1: Copley Standard Regen Resistor Dimensions.....	4
1.3.2: Copley Standard Regen Resistor Specifications.....	5
1.3.3: Copley Standard Regen Resistor Thermal Characteristics.....	5
1.4: Regen Circuit Wiring.....	6
1.4.1: Electrical Codes and Warnings.....	6
1.4.2: Amplifier Connector Locations.....	7
1.4.3: Regen Resistor (J3) Wiring.....	8
1.4.4: Regen Resistor Configuration with CME 2.....	9
<b>A: Regen Resistor Sizing and Configuration</b> .....	<b>11</b>
A.1: Sizing a Regen Resistor.....	12
A.1.1: Gather Required Information.....	12
A.1.2: Observe the Properties of Each Deceleration During a Complete Cycle of Operation.....	12
A.1.3: Calculate Energy Returned for Each Deceleration.....	13
A.1.4: Determine the Amount of Energy Dissipated by the Motor.....	13
A.1.5: Determine the Amount of Energy Returned to the Amplifier.....	13
A.1.6: Determine if Energy Returned Exceeds Amplifier Capacity.....	14
A.1.7: Calculate Energy to be Dissipated for Each Deceleration.....	14
A.1.8: Calculate Pulse Power of Each Deceleration that Exceeds Amplifier Capacity.....	14
A.1.9: Calculate Resistance Needed to Dissipate the Pulse Power.....	14
A.1.10: Calculate Continuous Power to be Dissipated.....	15
A.1.11: Select Fuses.....	15
A.2: Configuring a Custom Regen Resistor.....	16
A.2.1: Regen Configuration Objective and Warning.....	16
A.2.2: Regen Configuration Instructions.....	16

This page for notes.

# ABOUT THIS GUIDE

## Overview and Scope

---

This guide describes the selection, installation, and configuration of external regen resistors for Xenus Amplifiers.

## Related Documentation

---

Users should also read these Copley Controls documents:

- Xenus User Guide
- CME 2 User Guide

Links to these publications, along with hardware manuals and data sheets, can be found under the *Documents* heading of

<http://www.copleycontrols.com/Motion/Downloads/index.html>.

Information on Copley Controls Software can be found at:

<http://www.copleycontrols.com/Motion/Products/Software/index.html>

## Comments

---

Copley Controls Corporation welcomes your comments on this guide. See <http://www.copleycontrols.com> for contact information.

## Copyrights

---

No part of this document may be reproduced in any form or by any means, electronic or mechanical, including photocopying, without express written permission of Copley Controls Corporation.

Xenus and CME 2 are registered trademarks of Copley Controls Corporation.

## Document Validity

---

We reserve the right to modify our products. The information in this document is subject to change without notice and does not represent a commitment by Copley Controls Corporation. Copley Controls Corporation assumes no responsibility for any errors that may appear in this document.

## Product Warnings

---

Observe all relevant state, regional, and local safety regulations when installing and using this product. For safety and to assure compliance with documented system data, only Copley Controls Corporation should perform repairs to amplifiers.



**DANGER**

**DANGER: Hazardous voltages.**

Exercise caution when installing and adjusting.

**Failure to heed this warning can cause equipment damage, injury, or death.**



**DANGER**

**Risk of electric shock.**

High-voltage circuits on J1, J2, and J3 are connected to mains power.

**Failure to heed this warning can cause equipment damage, injury, or death.**



**DANGER**

**Use equipment as described.**

Operate amplifiers within the specifications provided in this manual.

**Failure to heed this warning can cause equipment damage, injury, or death.**

## Revision History

---

Revision	Date	DECO #	Comments
1.0	July 2003		Initial publication.
1.1	November 2004		Corrected <i>model number</i> in specifications table (p. 5).
2	February 2007	14988	Updated to describe new Copley regen resistor models.
3	June 2008	17137	Updated Web page references.

# CHAPTER

## 1: REGEN RESISTORS FOR XENUS

This chapter provides an overview of regeneration and using regen resistors with Xenus.

The contents of this chapter include:

Title	Page
1.1: Regen Resistor Theory.....	2
1.2: Amplifier Regen Circuit Output Specifications .....	3
1.3: Copley Standard Regen Resistors.....	4
1.4: Regen Circuit Wiring.....	6

## 1.1: Regen Resistor Theory

When a load is accelerated electrical energy is converted into mechanical energy. During deceleration the conversion is reversed. This is called regeneration. Some of this regenerated energy is lost to friction in the mechanical system. More of this energy is converted to heat due to  $I^2R$  losses in the motor windings, cabling and drive electronics. The remainder of the energy is added to the electrical energy already stored in the internal capacitor bank of the amplifier. The result of this energy being added is an increase in the voltage on the capacitor bank.

If too much energy is added to the capacitor bank, the voltage will rise to a point where the amplifier's over voltage protection will shut down the amplifier. To prevent this, a regen circuit shunts some of the energy into an external resistor, known as a regen resistor, when the voltage rises too high.

Xenus provides an internal transistor that is used in combination with an external resistor. Copley Controls supplies compatible external resistors. When using a resistor acquired from another source, be sure it meets the specifications described in [Regen Resistor Sizing and Configuration \(p. 11\)](#).

The amplifier protects the regen circuit against short circuit, and uses  $I^2T$  peak current/time algorithms to protect both the external resistor and internal transistor.

NOTE: The Xenus micro panel model has its own internal regen circuit and does not use an external regen resistor.



## 1.2: Amplifier Regen Circuit Output Specifications

This section describes the amplifier’s regen resistor circuit output specifications.

<b>Model</b>	<b>XTL-230-18</b>	<b>XTL-230-36</b>	<b>XTL-230-40</b>
Continuous Power	2 kW	4 kW	
Peak Power	5 kW	10 kW	
Minimum Resistance	30 Ω	15 Ω	
Minimum Resistor Wattage	25 W	50 W	
Turn On Voltage	+390 Vdc		
Turn Off Voltage	+380 Vdc		
DC Bus Capacitance	1760 μF nominal		
Regen Energy Absorption Capacity			
Input Voltage 120 Vac	108 joules		
208 Vac	57 joules		
240 Vac	32 joules		

### 1.3: Copley Standard Regen Resistors

Copley Controls provides two standard regen resistors for Xenus amplifiers: XTL-RA-03 and XTL-RA-04. XTL-RA-03 and XTL-RA-04 housing is shown below.



#### 1.3.1: Copley Standard Regen Resistor Dimensions

The diagram below shows XTL-RA-03 and XTL-RA-04 mounting dimensions (in mm).

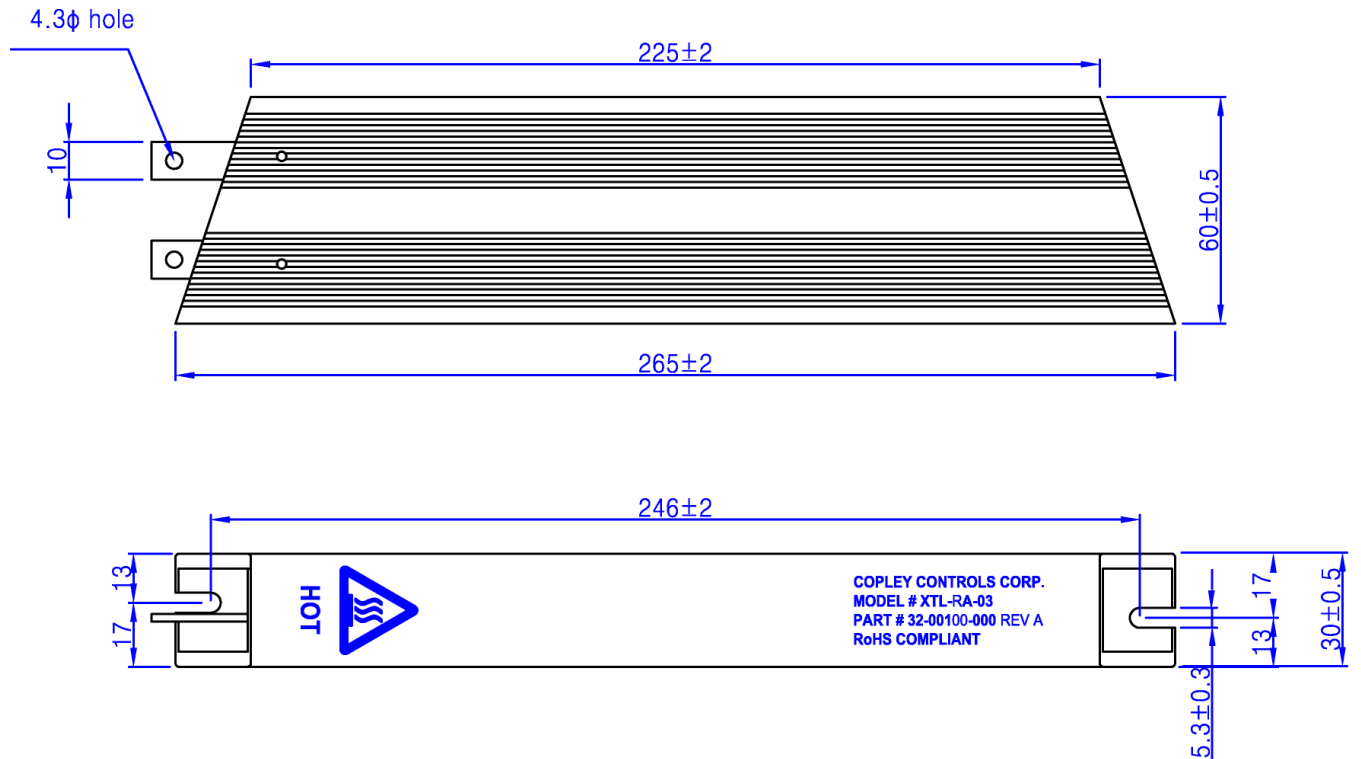

### 1.3.2: Copley Standard Regen Resistor Specifications

Specifications for Copley’s standard regen resistors are described below.

Model	Resistance	Default Continuous Power	Max Continuous Power	Peak Power	Peak Power Time	For Use With
XTL-RA-03	30 ohms	65 W	400 W	5 kW	1000 ms	XTL-230-18
XTL-RA-04	15 ohms	65 W	400 W	10 kW	1000 ms	XTL-230-36 XTL-230-40



**High Temperature Risk.**

Setting Default Continuous Power for a standard Copley regen resistor to a value greater than the default of 65 W may cause the resistor casing to heat to temperatures that could cause injury. If higher settings are required, contact Copley Controls customer support.

**WARNING**

**Failure to heed this warning can cause equipment damage or injury.**

### 1.3.3: Copley Standard Regen Resistor Thermal Characteristics

The following graph shows surface temperature rise vs. dissipated power for the XTL-RA-03 and XTL-RA-04 mounted to a control panel with the long surface of the resistor oriented vertically. Results may vary if the resistor is mounted differently.

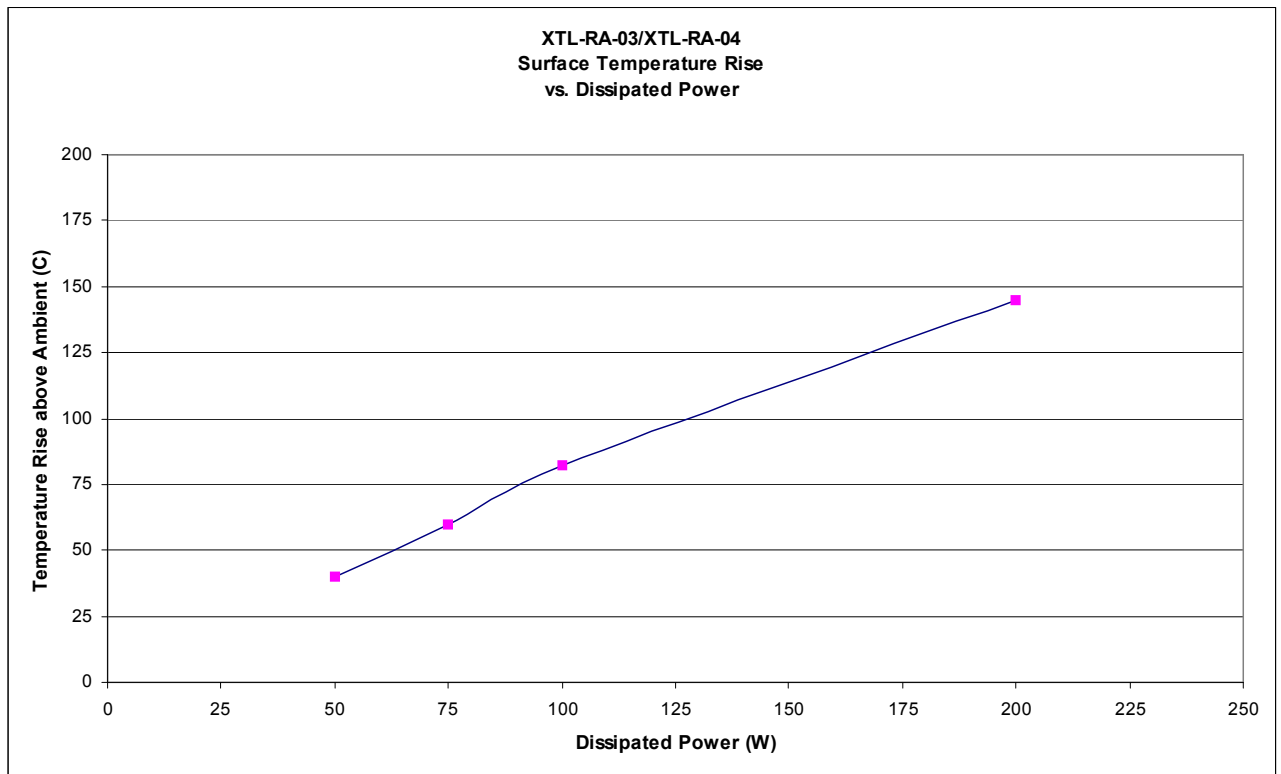

## 1.4: Regen Circuit Wiring

This section describes the wiring of the regen resistor connections.

### 1.4.1: Electrical Codes and Warnings

---

Be sure that all wiring complies with the National Electrical Code (NEC) or its national equivalent, and all prevailing local codes.



**DANGER**

**DANGER: Hazardous voltages.**

Exercise caution when installing and adjusting.

**Failure to heed this warning can cause equipment damage, injury, or death.**



**DANGER**

**Risk of electric shock.**

High-voltage circuits on J1, J2, and J3 are connected to mains power.

**Failure to heed this warning can cause equipment damage, injury, or death.**



**WARNING**

**Do not ground mains-connected circuits.**

With the exception of the ground pins on J1, J2, and J3, all of the other circuits on these connectors are mains-connected and must never be grounded.

**Failure to heed this warning can cause equipment damage.**

### 1.4.2: Amplifier Connector Locations

Connector locations are shown below. The regen connector is J3.

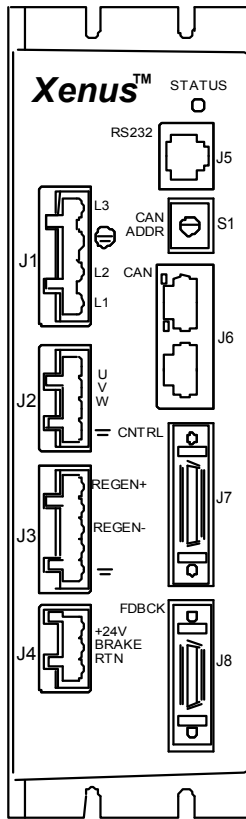

### 1.4.3: Regen Resistor (J3) Wiring

#### Mating Connector

Description	Euro-style, 5 position, 5.0 mm pluggable male terminal block.
Manufacturer PN	Wago 721-605/000-043
Wire Size	22 - 14 AWG
Recommended Wire	14 AWG, 600 V (Shielded cable used for CE compliance)
Wire Insertion/Extraction Tool	Wago 231-131
Connector and tool are included in connector kit XTL-CK	

#### Pin Description

Pin	Signal	Function
1	Regen +	+ DC Bus to one side of regen resistor
2	N/C	No connection
3	Regen -	Collector of regen transistor to one side of regen resistor
4	N/C	No connection
5	Ground	Enclosure ground and cable shield

#### Regen Resistor Wiring Diagram

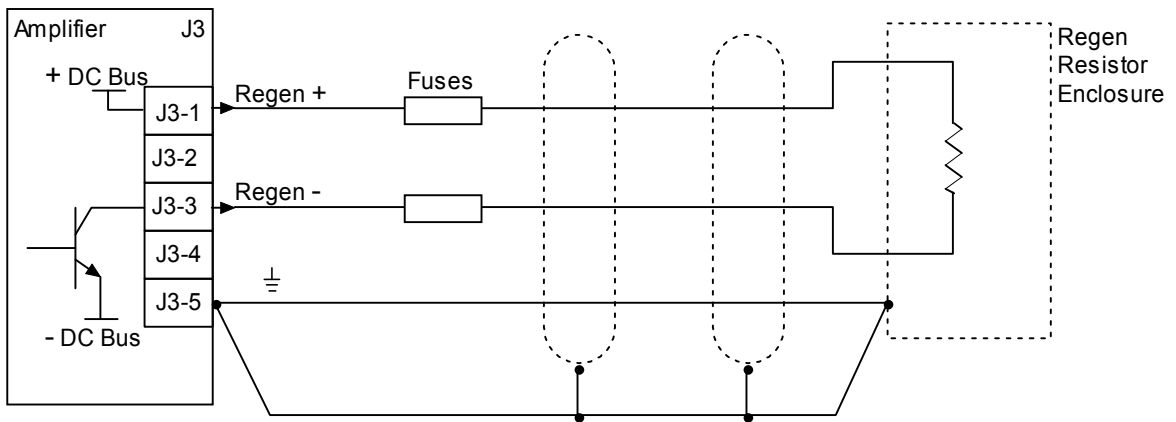

#### Regen Resistor Fusing

Recommended Fuses:

Regen Resistor	Fuse type
XTL-RA-03	Cooper Bussman KLM-8 or equivalent
XTL-RA-04	Cooper Bussman KLM-12 or equivalent
User Supplied	See <a href="#">Regen Resistor Sizing and Configuration</a> (p. 11).

### 1.4.4: Regen Resistor Configuration with CME 2

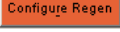
1.4.4.1 Click **Configure Regen** (  ) to open the *Regen Resistor* screen.



1.4.4.2 Select a resistor option.

Option	Description
None	No external regen resistor is used.
XTL-RA-03	Standard regen resistors supplied by Copley Controls.
XTL-RA-04	
Custom Resistor	User-supplied resistor. See <a href="#">Regen Resistor Sizing and Configuration (p. 11)</a> .

1.4.4.3 Click **OK** to save regen settings to flash memory and close the *Regen Resistor* screen  
 OR  
 click **Cancel** to restore to previous values and close the screen.

This page for notes.



# APPENDIX

## A: REGEN RESISTOR SIZING AND CONFIGURATION

This chapter describes the formulas used to determine if a regen resistor is required and what the optimal resistor characteristics would be for a given application.

The contents of this chapter include:

<b>Title</b>	<b>Page</b>
A.1: Sizing a Regen Resistor.....	12
A.2: Configuring a Custom Regen Resistor .....	16

## A.1: Sizing a Regen Resistor

### A.1.1: Gather Required Information

---

Calculating the power and resistance of the regen resistor requires information about the amplifier and the rotary or linear motor application.

- A.1.1.1 For all applications, gather the following information:
- 1 Details of the complete motion profile, including times and velocities
  - 2 Amplifier model number
  - 3 Applied line voltage to the amplifier
  - 4 Torque constant of the motor
  - 5 Resistance (line-to-line) of the motor windings.
- A.1.1.2 For rotary motor applications, gather this additional information:
- 1 Load inertia seen by the motor
  - 2 Inertia of the motor.
- A.1.1.3 For linear motor applications, gather this additional information:
- 1 Mass of the moving load
  - 2 Mass of the motor forcer block if the motor rod is stationary  
OR  
Mass of the motor rod if the motor forcer block is stationary.

### A.1.2: Observe the Properties of Each Deceleration During a Complete Cycle of Operation

---

- A.1.2.1 For each deceleration during the motion cycle, determine:
- 1 Speed at the start of the deceleration
  - 2 Speed at the end of the deceleration
  - 3 Time over which the deceleration takes place.

### A.1.3: Calculate Energy Returned for Each Deceleration

---

Use the following formulas to calculate the energy returned during each deceleration:

**Rotary motor:**

$$E_{\text{dec}} = \frac{1}{2} J_t (\omega_1^2 - \omega_2^2)$$

Where:

$E_{\text{dec}}$  = Energy returned by the deceleration, in joules.

$J_t$  = Load inertia on the motor shaft plus the motor inertia in  $\text{kg m}^2$ .

$\omega_1$  = Shaft speed at the start of deceleration in radians per second.

$\omega_2$  = Shaft speed at the end of deceleration in radians per second.

$\omega$  =  $2\pi$  RPS.

**Linear motor:**

$$E_{\text{dec}} = \frac{1}{2} M_t (V_1^2 - V_2^2)$$

Where:

$E_{\text{dec}}$  = Energy returned by the deceleration, in joules.

$M_t$  = Total mass of the load and the moving part of the motor in kg.

$V_1$  = Velocity at the start of deceleration in meters per second.

$V_2$  = Velocity at the end of deceleration in meters per second.

### A.1.4: Determine the Amount of Energy Dissipated by the Motor

---

Calculate the amount of energy dissipated by the motor due to current flow through the motor winding resistance using the following formulas.

$$P_{\text{motor}} = \frac{3}{4} R_{\text{winding}} (F / Kt)^2$$

Where:

$P_{\text{motor}}$  = Power dissipated in the motor in watts.

$R_{\text{winding}}$  = Line to line resistance of the motor.

$F$  = Force needed to decelerate the motor:

Nm for rotary applications

N for linear applications

$Kt$  = Torque constant for the motor:

Nm/Amp for rotary applications

N/Amp for linear applications

$$E_{\text{motor}} = P_{\text{motor}} T_{\text{decel}}$$

Where:

$E_{\text{motor}}$  = Energy dissipated in the motor in joules

$T_{\text{decel}}$  = Time of deceleration in seconds

### A.1.5: Determine the Amount of Energy Returned to the Amplifier

---

Calculate the amount of energy that will be returned to the amplifier for each deceleration using the following formula.

$$E_{\text{returned}} = E_{\text{dec}} - E_{\text{motor}}$$

Where:

$E_{\text{returned}}$  = Energy returned to the amplifier, in joules

$E_{\text{dec}}$  = Energy returned by the deceleration, in joules

$E_{\text{motor}}$  = Energy dissipated by the motor, in joules

### A.1.6: Determine if Energy Returned Exceeds Amplifier Capacity

---

Compare the amount of energy returned to the amplifier in each deceleration with the amplifier's energy absorption capacity. For related amplifier specifications, see [Amplifier Regen Circuit Output Specifications](#) (p. 3).

For mains voltages not listed in the specification table, use the following formula to determine the energy that can be absorbed by the amplifier.

$$W_{\text{capacity}} = \frac{1}{2} C (V_{\text{regen}}^2 - (1.414 V_{\text{mains}})^2)$$

Where:

$W_{\text{capacity}}$  = The energy that can be absorbed by the bus capacitors, in joules.

$C$  = Bus capacitance in farads.

$V_{\text{regen}}$  = Voltage at which the regen circuit turns on, in volts.

$V_{\text{mains}}$  = Mains voltage applied to the amplifier, in volts AC.

### A.1.7: Calculate Energy to be Dissipated for Each Deceleration

---

For each deceleration where the energy exceeds the amplifier's capacity, use the following formula to calculate the energy that must be dissipated by the regen resistor:

$$E_{\text{regen}} = E_{\text{returned}} - E_{\text{amp}}$$

Where:

$E_{\text{regen}}$  = Energy that must be dissipated in the regen resistor, in joules.

$E_{\text{returned}}$  = Energy delivered back to the amplifier from the motor, in joules.

$E_{\text{amp}}$  = Energy that the amplifier will absorb, in joules.

### A.1.8: Calculate Pulse Power of Each Deceleration that Exceeds Amplifier Capacity

---

For each deceleration where energy must be dissipated by the regen resistor, use the following formula to calculate the pulse power that will be dissipated by the regen resistor:

$$P_{\text{pulse}} = E_{\text{regen}} / T_{\text{decel}}$$

Where:

$P_{\text{pulse}}$  = Pulse power in watts.

$E_{\text{regen}}$  = Energy that must be dissipated in the regen resistor, in joules.

$T_{\text{decel}}$  = Time of the deceleration in seconds.

### A.1.9: Calculate Resistance Needed to Dissipate the Pulse Power

---

Using the maximum pulse power from the previous calculation, calculate the resistance value of the regen resistor required to dissipate the maximum pulse power: For related amplifier specifications, see [Amplifier Regen Circuit Output Specifications](#) (p. 3).

$$R = V_{\text{regen}}^2 / P_{\text{pulse max}}$$

Where:

$R$  = Resistance in ohms.

$P_{\text{pulse max}}$  = The maximum pulse power.

$V_{\text{regen}}$  = The voltage at which the regen circuit turns on.

Choose a standard value of resistance less than the calculated value. This value must be greater than the minimum regen resistor value specified in [Amplifier Regen Circuit Output Specifications](#) (p. 3).

### A.1.10: Calculate Continuous Power to be Dissipated

---

Use the following formula to calculate the continuous power that must be dissipated by the regen resistor. Use each deceleration where energy is dissipated by the regen resistor.

$$P_{\text{cont}} = (E_{\text{regen 1}} + E_{\text{regen 2}} + E_{\text{regen ...}}) / T_{\text{cycle}}$$

Where:

$P_{\text{cont}}$  = The continuous power that will be dissipated by the resistor in watts.

$E_{\text{regen n}}$  = Energy being dissipated during decelerations, in joules.

$T_{\text{cycle}}$  = Total cycle time in seconds.

Choose a resistor with a power rating equal to or greater than the calculated continuous power. Verify that the calculated power value is less than the continuous regen power rating specified in [Amplifier Regen Circuit Output Specifications \(p. 3\)](#).

### A.1.11: Select Fuses

---

For custom regen resistors, Cooper Bussman KLM fuses, or equivalent, should be selected. The peak and continuous currents, as well as the peak current time, must be taken into consideration for proper fuse selection. The duration of the peak current is the deceleration time ( $T_{\text{decel}}$ ) associated with the maximum pulse power regen event.

Use the following formulas to determine the minimum peak and continuous current ratings of the fuse. For related amplifier specifications, see [Amplifier Regen Circuit Output Specifications \(p. 3\)](#).

The peak current is determined by the chosen regen resistor value.

$$I_{\text{peak}} = V_{\text{regen}} / R_{\text{regen}}$$

Where:

$I_{\text{peak}}$  = The current through the regen resistor during regeneration in amps.

$V_{\text{regen}}$  = The voltage at which the regen circuit turns on.

$R_{\text{regen}}$  = The resistance value of the chosen regen resistor in ohms.

The continuous current is determined by the continuous regen power.

$$I_{\text{cont}} = P_{\text{cont}} / V_{\text{regen}}$$

Where:

$I_{\text{cont}}$  = The minimum continuous current rating the fuse requires in amps.

$P_{\text{cont}}$  = The continuous power calculated in the previous step, in watts.

$V_{\text{regen}}$  = The voltage at which the regen circuit turns on.

## A.2: Configuring a Custom Regen Resistor

### A.2.1: Regen Configuration Objective and Warning

---

Configure the amplifier to operate properly with the custom resistor.



**WARNING**

**Incorrect values may damage amplifier or external regen resistor.**

For the I<sup>2</sup>T algorithms to work correctly, the values entered in the following steps must be correct. Damage to the external regen resistor may result from incorrect values entered. Damage to the amplifier may result if an incorrect resistance value is entered.

**Failure to heed this warning can cause equipment damage.**

### A.2.2: Regen Configuration Instructions

---

A.2.2.1 On the *Main* screen, click **Configure Regen** () to open the *Regen Resistor* screen.



A.2.2.2 Select *Custom Resistor* and then click **Configure** to open the *Custom Regen Configuration* screen.

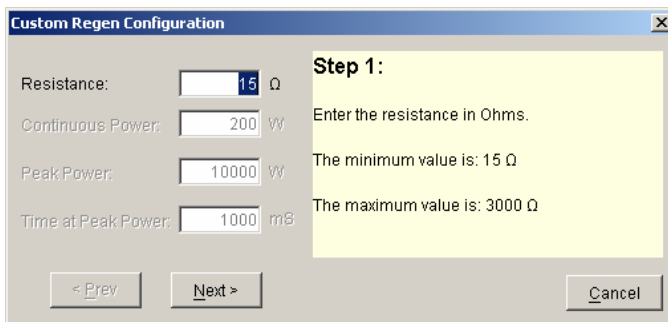

A.2.2.3 Enter a **Resistance** within the range described on the screen. Click **Next** for Step 2.

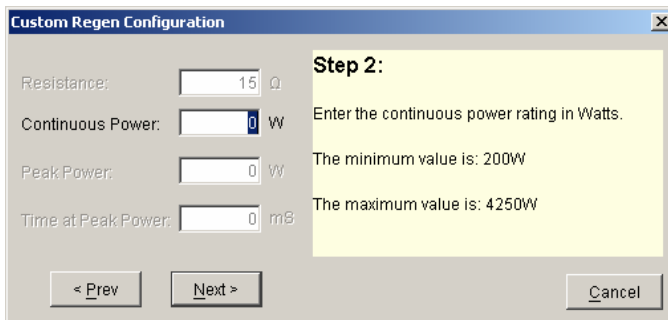

A.2.2.4 Enter a **Continuous Power** within the range described. Click **Next** for Step 3.

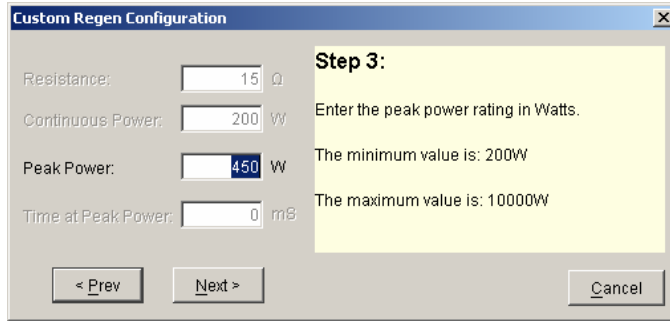

A.2.2.5 Enter a **Peak Power** within the range described. Click **Next** for Step 4.

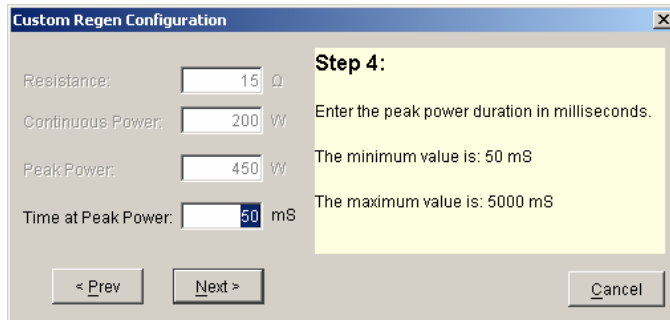

A.2.2.6 Click **Next** for Step 5.

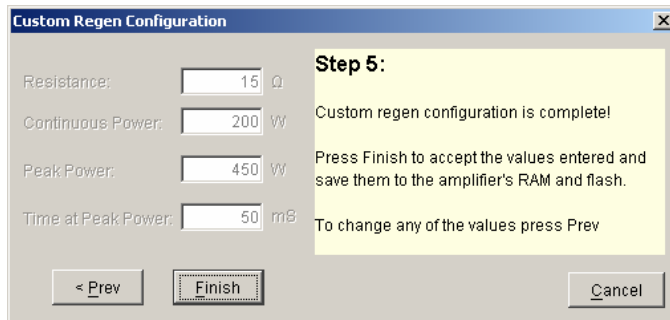

A.2.2.7 Review the configuration.

A.2.2.8 Click **Finish** to save the configuration to volatile and flash memory and close the screen

OR

click **Prev** to modify any values

OR

click **Cancel** to close the screen without saving any changes.

Xenus™ Regeneration Guide

P/N 95-00306-000

Revision 3

June 2008

© 2003, 2004, 2006, 2007, 2008

Copley Controls Corporation

20 Dan Road

Canton, MA 02021 USA

All rights reserved