

Overview

Peak Force (Fpk)

Product Type		10N	100N	500N	1000N	5000N	10000N	15000N	20000N
Ironless Technology	AUM 1,2,3,4,5,6	[Force range bar]							
	AWM 1,2,3,4,5	[Force range bar]							
	ACR 240,335,820,1525	[Force range bar]							
Iron Core Technology	AJM 30,50,80,100	[Force range bar]							
	AQM 8,24,30,50,80	[Force range bar]							
	AKM 30,50,100,150,200	[Force range bar]							

Technical specifications for Ironless Technology:

- AUM: Fcn=3,0N-2340N, Fpk=11,9N-16200N
- AWM: Fcn=4,5N-414,8N, Fpk=22,3N-2986,3N
- ACR: Tcn = 24,3Nm - 460,7Nm, Tpk = 72,8Nm - 1382,2Nm

Technical specifications for Iron Core Technology:

- AJM: Fcn=68,1N-446,8N, Fpk=214,7N-1409,1N
- AQM: Fcn=20,3N-405N, Fpk=49,7N-994,4N
- AKM: Fcn=108,4N-4817,7N, Fpk=241,6N-12684,3N

Flexible structure design contributes to excellent and simple high-precision control system:

- Multi-carriage structure
- Optional moving track design instead of moving coil, eliminating cable management and potential cable damage
- Multiple coils can be connected in series or parallel to generate higher force and faster speed while maintaining compact size

Please contact Akribis Sales engineers for more details (cust-service@akribis-sys.com).

Applications & Industries: electronics, semiconductor, solar energy, lithium battery, PCB, FPD, HDD, LED, lathe, vehicle electronics, packaging, printing, optics, biomedical and many more.



AUM SERIES

- ▶ Ironless technology
- ▶ Zero cogging force
- ▶ Patented technology
- ▶ Small electrical and mechanical constant
- ▶ High continuous force and peak force

Introduction

AUM series Ironless DC brushless linear motors are compact in size but high in force density, achieving larger thrust force.

F_{cn} (Continuous force) = 3N ~ 2340N

F_{pk} (Peak force) = 11.9N ~ 16200N

Features

- ▶ Ironless technology and no cogging force
- ▶ High continuous and peak force
- ▶ Optional hall sensors
- ▶ High motor constant
- ▶ Wide range of forces and sizes to choose from
- ▶ Optional air cooling and water cooling configurations

Applications

Applicable to point-to-point micron/nanometer level positioning; unlimited travel stroke with top speed of 5m/s or faster; low velocity ripple during both fast and low speed scanning; precise force control with fine resolution.
 Applications & Industries: high speed and precision machines for positioning, motion profile tracking, velocity controlling used in front-end & back-end wafer handling and inspection, photovoltaic and lithium battery systems, glass and LCD applications, biomedical equipment, printing machines, and laser processing machines.

Model	Coil Length (mm)	Continuous Force (F _{cn}) / Peak Force (F _{pk})							Unit: N
		10	50	100	500	1000	1500	2000	
AUM1-S1 19.0	AUM1-S1	22	3.0 / 11.9						
	AUM1-S2	43	6.0 / 23.8						
	AUM1-S3	64	8.9 / 36.7						
	AUM1-S4	85	11.9 / 47.8						
	AUM1-S5	106	14.9 / 59.5						
AUM2-S1 22.0	AUM2-S1	31	8.8 / 44						
	AUM2-S2	61	17.6 / 88						
	AUM2-S3	91	26.4 / 132						
	AUM2-S4	121	35.2 / 176						
	AUM2-S8	241	26.4 / 362						
AUM3-S1 35.0	AUM3-S1	61	28 / 144						
	AUM3-S2	121	57 / 289						
	AUM3-S3	181	85 / 433						
	AUM3-S4	241	113 / 578						
	AUM3-S6	361	170 / 867						
AUM4-S1 39.0	AUM4-S1	61	55 / 312						
	AUM4-S2	121	110 / 624						
	AUM4-S3	181	166 / 936						
	AUM4-S4	241	221 / 1248						
	AUM4-S5	301	276 / 1560						
AUM5-S1 50.0	AUM4-S6	361	331 / 1872						
	AUM4-S8	481	442 / 2496						
	AUM5-S1	61	98 / 707						
	AUM5-S2	121	197 / 1415						
	AUM5-S3	181	287 / 2112						
AUM6-P5-S4 64.5	AUM5-S4	241	388 / 2830						
	AUM5-S5	301	491 / 3537						
	AUM5-S6	361	590 / 4244						
	AUM5-S8-V107	481	786 / 5869						
	AUM5-S9-V80	757	884 / 6367						
AUM6-P8-S6 212.0	AUM5-S10-V107	841	983 / 7078						
	AUM5-S12-V107	1009	1179 / 8089						
	AUM6-P5-S4	337	780 / 5400						
	AUM6-P8-S6	505	1170 / 8100						
	AUM6-P5-S8	673	1580 / 10800						
AUM6-P8-S9 212.0	AUM6-P8-S9	757	1755 / 12150						
	AUM6-P7-S10	841	1950 / 13500						
	AUM6-P8-S12	1009	2340 / 16200						

● No hall sensor.
 ● Continuous force is measured under the condition of self-cooling. Please refer to the detail parameters table for the continuous force under the condition of air cooling or water cooling.

AUM1

Performance Parameters	Symbol	Unit	AUM1-S1	AUM1-S2	AUM1-S3	AUM1-S4	AUM1-S5
			Series	Series	Series	Series	Series
Continuous Force (NC) @100°C	F _{cn}	N	3.0	6.0	8.9	11.9	14.9
Peak Force	F _{pk}	N	11.9	23.8	35.7	47.6	59.5
Force Constant ±10%	K _f	N/Arms	1.75	3.50	5.25	7.00	8.75
Back EMF Constant ±10%	K _e	Vpeak/(m/s)	1.4	2.9	4.3	5.7	7.1
Motor Constant @25°C	K _m	N/Sqrt(W)	1.5	2.1	2.5	2.9	3.1
Resistance (L-L) 25°C ±10%	R ₂₅	Ω	0.92	1.92	2.92	3.92	5.32
Inductance (L-L) ±40%	L	mH	0.11	0.22	0.31	0.41	0.55
Electrical Time Constant	T _e	ms	0.12	0.11	0.11	0.10	0.10
Continuous Current (NC) @100°C	I _{cn}	Arms	1.70	1.70	1.70	1.70	1.70
Peak Current	I _{pk}	Arms	6.80	6.80	6.80	6.80	6.80
Continuous Power Dissipation (NC) @100°C	P _{cn}	W	5.15	10.74	16.32	21.91	29.73
Max. Coil Temperature	T _{max}	°C	100	100	100	100	100
Thermal Dissipation Constant (NC)	K _{th}	W/°C	0.1	0.1	0.2	0.3	0.4
Max. Bus Voltage	U _{bus}	Vdc	330	330	330	330	330
Magnetic Period	T _{SN}	mm	21.0	21.0	21.0	21.0	21.0
Attraction Force	F _a	kN	0	0	0	0	0

Mechanical Parameters		AUM1-S1	AUM1-S2	AUM1-S3	AUM1-S4	AUM1-S5
Coil Mass (NC)	m _{cn}	kg	0.025	0.050	0.075	0.100
Coil Length (NC)	L _{cn}	mm	22.0	43.0	64.0	85.0
Track Mass Per Meter	m _{track}	kg/m	2.37	2.37	2.37	2.37

Other Information		
Insulation Class	Class B (130°C)	
Protection Grade	IP00	
Compliance with Global Standards	RoHS, CE	
Ambient Temperature	Operation	0°C to 40°C (non-freezing)
	Storage	-15°C to 70°C (non-freezing)
Ambient Humidity	Operation	10%RH to 80%RH (non-condensing)
	Storage	10%RH to 90%RH (non-condensing)
Recommended Ambience	Indoor (no direct sunlight); No corrosive gas, inflammable gas, oil mist or dust.	

Dimension

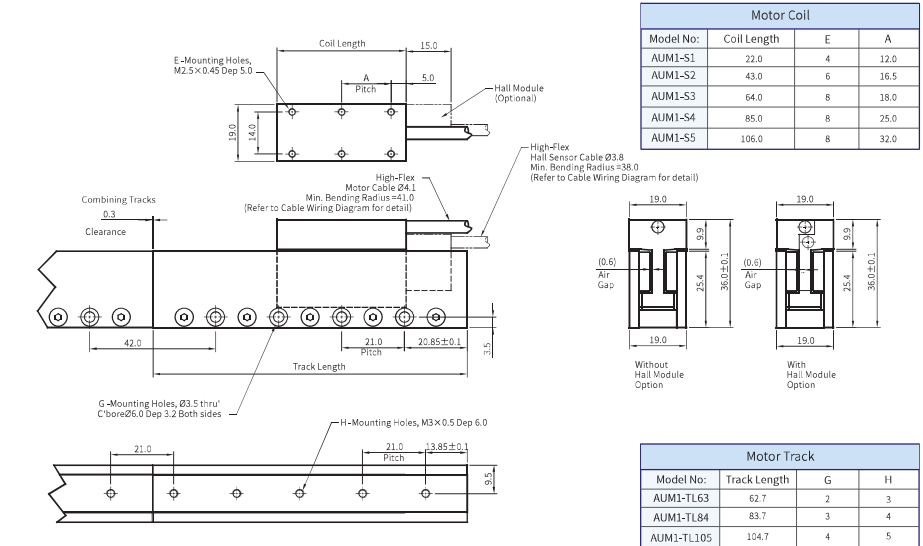

Force-Speed Curve

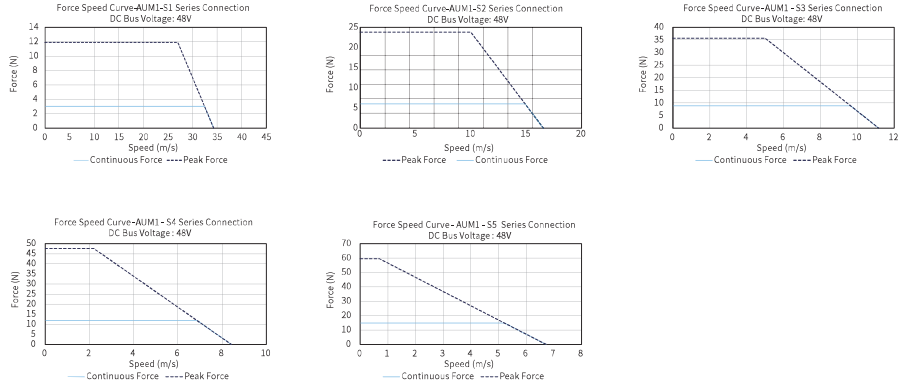

Part Numbering

Motor Coil

AUM1-S-S3-HF-0.5-FB

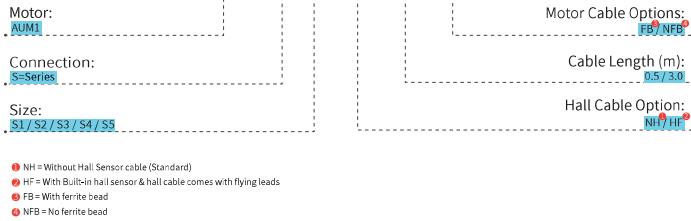

- NH = Without Hall Sensor cable (Standard)
- HF = With Built-in hall sensor & hall cable comes with flying leads
- FB = With ferrite bead
- NFB = No ferrite bead

Motor Track

AUM1-TL63



AUM2

Performance Parameters	Symbol	Unit	AUM2-S1		AUM2-S2		AUM2-S3		AUM2-S4		AUM2-S8	
			Series	Parallel	Series	Parallel	Series	Parallel	Series	Parallel		
Continuous Force (NC) @100°C	F _{cn}	N	8.8	17.6	17.6	25.4	26.6	35.2	35.2	70.4	70.4	
Peak Force	F _{pk}	N	44.0	88.0	88.0	132.0	132.8	176.0	176.0	352.0	352.0	
Force Constant ±10%	K _f	N/Arms	5.5	11.0	5.5	16.5	8.3	22.0	11.0	44.0	22.0	
Back EMF Constant ±10%	K _e	V/peak/(m/s)	4.5	9.0	4.5	13.5	6.8	18.0	9.0	35.9	18.0	
Motor Constant @25°C	K _m	N/Sqrt(W)	2.6	3.6	3.4	4.4	4.5	5.0	4.9	7.1	7.1	
Resistance (L-L) 25°C ±10%	R ₂₅	Ω	3.07	6.32	1.78	9.57	2.26	12.82	3.32	25.82	6.32	
Inductance (L-L) ±40%	L	mH	0.75	1.50	0.51	2.25	0.56	3.00	0.75	6.00	1.50	
Electrical Time Constant	T _e	ms	0.24	0.24	0.29	0.24	0.25	0.23	0.23	0.23	0.24	
Continuous Current (NC) @100°C	I _{cn}	Arms	1.6	1.6	3.2	1.6	3.2	1.6	3.2	1.6	3.2	
Peak Current	I _{pk}	Arms	8.0	8.0	16.0	8.0	16.0	8.0	16.0	8.0	16.0	
Continuous Power Dissipation (NC) @100°C	P _{cn}	W	15.2	31.3	35.3	47.4	44.7	63.5	65.8	127.8	125.1	
Max. Coil Temperature	T _{max}	°C	100	100	100	100	100	100	100	100	100	
Thermal Dissipation Constant (NC)	K _{th}	W/°C	0.2	0.4	0.5	0.6	0.6	0.8	0.9	1.7	1.7	
Max. Bus Voltage	U _{bus}	Vdc	330	330	330	330	330	330	330	330	330	
Magnetic Period	τ _{ML}	mm	30.0	30.0	30.0	30.0	30.0	30.0	30.0	30.0	30.0	
Attraction Force	F _a	kN	0	0	0	0	0	0	0	0	0	

- Measurement is taken at ambient temperature 25°C. Value depends on the thermal environment. Abbreviations: NC-Natural Cooling, AC-Air Cooling, WC-Water Cooling.
- Resistance is measured by DC current with standard 0.5 m cable.
- Inductance is measured by current frequency of 1 kHz. The variation range of AUM inductance is ±40% because three phase inductances are different. The value in the catalog is the average between the maximum and minimum values. For each phase, the variation range is ±20%. The contents of dataset are subject to change without prior notice.

Dimension

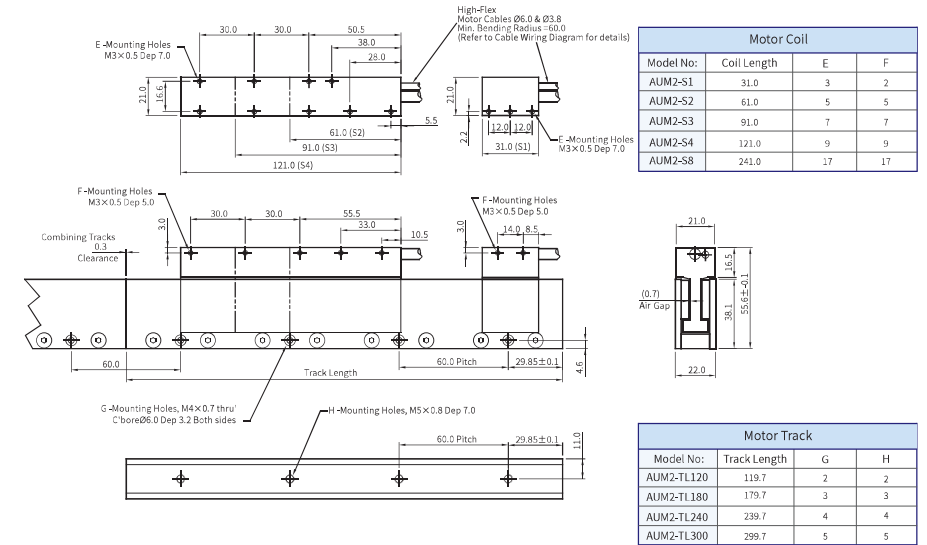

Introduction | Sizing Guide | Frequently Asked Questions | Linear Motors | Voice Coil Motors | Direct Drive Rotary Motors | Motion Control of Gantry Stages | Akribis systems

Introduction | Sizing Guide | Frequently Asked Questions | Linear Motors | Voice Coil Motors | Direct Drive Rotary Motors | Motion Control of Gantry Stages | Akribis systems

Force-Speed Curve

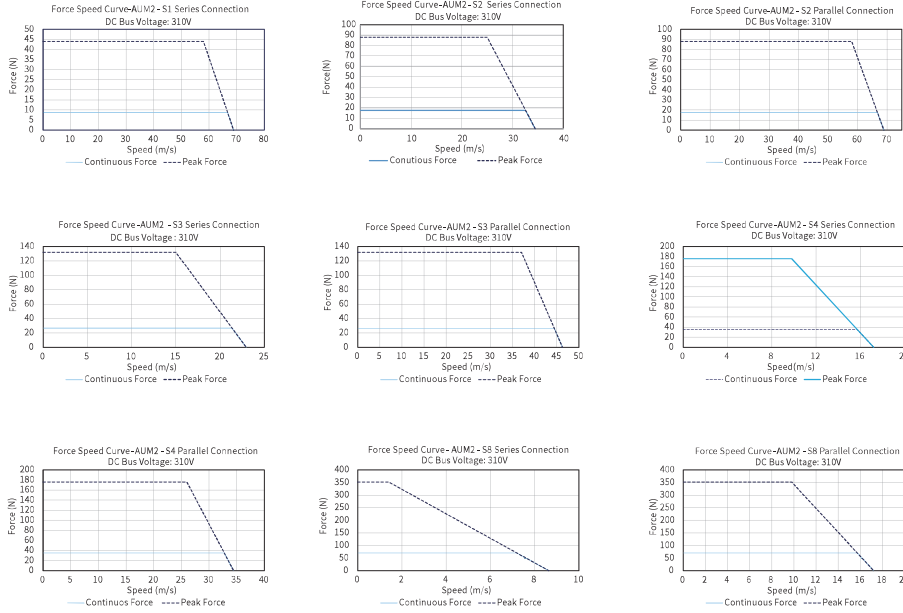

Part Numbering

Motor Coil

AUM2-S-S3-K-HF-0.5-FB

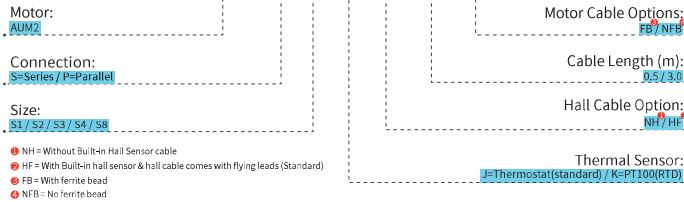

Motor Track

AUM2-TL120



AUM3

Performance Parameters	Symbol	Unit	AUM3-S1		AUM3-S2		AUM3-S3		AUM3-S4		AUM3-S6	
			Series	Series/Parallel	Series/Parallel	Series/Parallel	Series/Parallel	Series/Parallel				
Continuous Force (NC) @100°C	F _{in}	N	28	57	57	85	85	113	113	170	170	
Continuous Force (AC) @100°C	F _{ca}	N	34	68	68	102	102	136	136	203	203	
Continuous Force (WC) @100°C	F _{cw}	N	37	73	73	110	110	147	147	220	220	
Peak Force	F _{pk}	N	144	289	289	433	433	578	578	867	867	
Force Constant ±10%	K _f	N/Arms	15.7	31.4	15.7	47.1	23.6	62.8	31.4	47.1	47.1	
Back EMF Constant ±10%	K _e	Vpeak/(m/s)	12.8	25.6	12.8	38.5	19.2	51.3	25.6	38.5	38.5	
Motor Constant @25°C	K _m	N/Sort(W)	5.8	8.4	8.0	10.3	10.0	11.9	12.1	14.7	14.7	
Resistance (L-L) @25°C ±10%	R ₂₅	Ω	4.95	9.22	2.56	13.92	3.73	18.62	4.52	6.87	6.87	
Inductance (L-L) ±40%	L	mH	3.13	6.26	1.57	9.39	2.35	12.52	3.13	4.70	4.70	
Electrical Time Constant	T _e	ms	0.63	0.63	0.61	0.67	0.53	0.67	0.69	0.68	0.68	
Continuous Current (NC) @100°C	I _{cn}	Arms	1.8	1.8	3.6	1.8	3.6	1.8	3.6	3.6	3.6	
Continuous Current (AC) @100°C	I _{ca}	Arms	2.2	2.2	4.3	2.2	4.3	2.2	4.3	4.3	4.3	
Continuous Current (WC) @100°C	I _{cw}	Arms	2.3	2.3	4.7	2.3	4.7	2.3	4.7	4.7	4.7	
Peak Current	I _{pk}	Arms	9.2	9.2	18.4	9.2	18.4	9.2	18.4	18.4	18.4	
Continuous Power Dissipation (NC) @100°C	P _{cn}	W	31.0	57.8	64.2	93.5	116.6	113.3	172.2	172.2	172.2	
Continuous Power Dissipation (AC) @100°C	P _{ca}	W	44.7	83.2	92.4	125.6	134.6	168.0	163.1	247.9	247.9	
Continuous Power Dissipation (WC) @100°C	P _{cw}	W	52.4	97.6	108.5	147.4	158.0	197.1	191.5	291.0	291.0	
Max. Coil Temperature	T _{max}	°C	100	100	100	100	100	100	100	100	100	
Thermal Dissipation Constant (NC)	K _{thn}	W/°C	0.4	0.8	0.9	1.2	1.2	1.6	1.5	2.3	2.3	
Thermal Dissipation Constant (AC)	K _{thca}	W/°C	0.6	1.1	1.2	1.7	1.8	2.2	2.2	3.3	3.3	
Thermal Dissipation Constant (WC)	K _{thcw}	W/°C	0.7	1.3	1.4	2.0	2.1	2.6	2.6	3.9	3.9	
Max. Bus Voltage	U _{bus}	Vdc	330	330	330	330	330	330	330	330	330	
Magnetic Period	T _{ms}	mm	60	60	60	60	60	60	60	60	60	
Attraction Force	F _a	kN	0	0	0	0	0	0	0	0	0	

Mechanical Parameters											
Coil Mass (NC)	m _{cn}	kg	0.22	0.45	0.45	0.68	0.68	0.91	0.91	1.37	1.37
Coil Length (NC)	L _{cn}	mm	61.0	121.0	121.0	181.0	181.0	241.0	241.0	361.0	361.0
Coil Length (AC)	L _{ca}	mm	61.0	121.0	121.0	181.0	181.0	241.0	241.0	361.0	361.0
Coil Length (WC)	L _{cw}	mm	61.0	121.0	121.0	181.0	181.0	241.0	241.0	361.0	361.0
Track Mass Per Meter	m _{track}	kg/m	8.33	8.33	8.33	8.33	8.33	8.33	8.33	8.33	8.33

Dimension

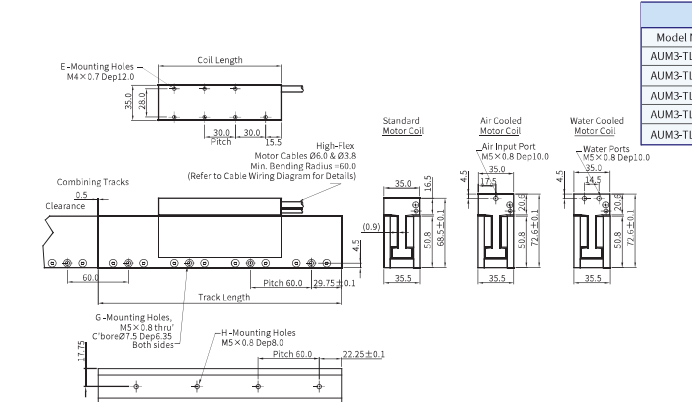

Motor Track			
Model No.	Track Length	G	H
AUM3-TL120	119.5	2	2
AUM3-TL180	179.5	3	3
AUM3-TL240	239.5	4	4
AUM3-TL300	299.5	5	5
AUM3-TL600	599.5	10	10

Motor Coil			
Model No.	Coil Length	E	
AUM3-S1	61.0	3	
AUM3-S2	121.0	7	
AUM3-S3	181.0	11	
AUM3-S4	241.0	15	
AUM3-S6	361.0	23	

For air or water cooled models, Coil Length and E are the same as the standard model.

Introduction | Sizing Guide | Frequently Asked Questions | Linear Motors | Voice Coil Motors | Direct Drive Rotary Motors | Motion Control of Gantry Stages | Artixis systems

Introduction | Sizing Guide | Frequently Asked Questions | Linear Motors | Voice Coil Motors | Direct Drive Rotary Motors | Motion Control of Gantry Stages | Artixis systems

Force-Speed Curve

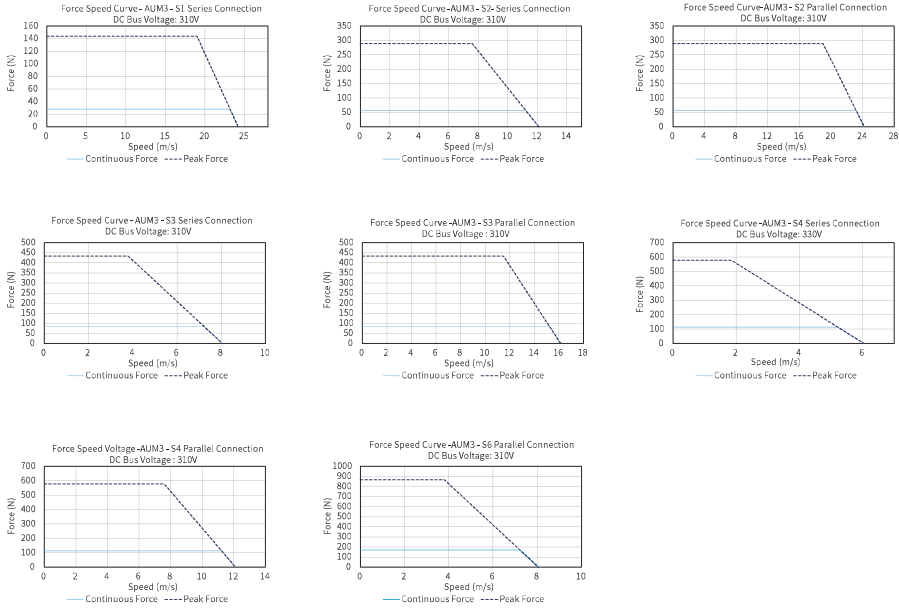

Part Numbering

Motor Coil

AUM3-S-S3-K-HF-0.5-FB

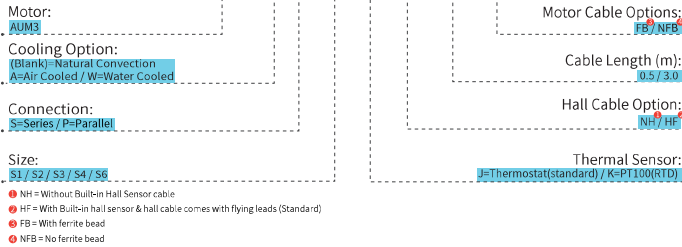

Motor Track

AUM3-TL120



AUM4

		AUM4-S1	AUM4-S2	AUM4-S3	AUM4-S4	AUM4-S5	AUM4-S6	AUM4-S8
Performance Parameters								
Continuous Force (NC) @100°C	F _{cn} N	55	110	110	166	221	276	331
Continuous Force (AC) @100°C	F _{ca} N	66	132	132	199	265	331	397
Continuous Force (WC) @100°C	F _{cw} N	72	144	144	215	287	359	431
Peak Force	F _{pk} N	312	624	624	936	1248	1560	1872
Force Constant ±10%	K _f N/Arms	24.0	48.0	24.0	72.0	36.0	96.0	48.0
Back EMF Constant ±10%	K _v V/sek/(m/s)	19.6	39.2	19.6	58.8	29.4	78.4	39.2
Motor Constant @25°C	K _m N·Sqrt(W)	9.3	13.0	12.7	15.9	15.7	18.4	18.6
Resistance (L-L) @25°C ±10%	R _{zs} Ω	4.42	9.02	2.37	13.62	3.52	18.22	4.42
Inductance (L-L) ±40%	L	mH	3.50	7.00	1.75	10.50	2.63	14.00
Electrical Time Constant	τ _e	ms	0.79	0.78	0.74	0.77	0.75	0.79
Continuous Current (NC) @100°C	I _{cn} Arms	2.3	2.3	4.6	2.3	4.6	2.3	4.6
Continuous Current (AC) @100°C	I _{ca} Arms	2.8	2.8	5.5	2.8	5.5	2.8	5.5
Continuous Current (WC) @100°C	I _{cw} Arms	3.0	3.0	6.0	3.0	6.0	3.0	6.0
Peak Current	I _{pk} Arms	13.0	13.0	26.0	13.0	26.0	13.0	26.0
Continuous Power Dissipation (NC) @100°C	P _{cn} W	45	92	97	139	144	186	181
Continuous Power Dissipation (AC) @100°C	P _{ca} W	65	133	140	201	207	268	260
Continuous Power Dissipation (WC) @100°C	P _{cw} W	76	156	164	235	243	315	306
Max. Coil Temperature	T _{max} °C	100	100	100	100	100	100	100
Thermal Dissipation Constant (NC)	K _{thn} W/°C	0.6	1.2	1.3	1.9	1.9	2.5	2.4
Thermal Dissipation Constant (AC)	K _{thca} W/°C	0.9	1.8	1.9	2.7	2.8	3.6	3.5
Thermal Dissipation Constant (WC)	K _{thcw} W/°C	1.0	2.1	2.2	3.1	3.2	4.2	4.1
Max. Bus Voltage	U _{bus} Vdc	330	330	330	330	330	330	330
Magnetic Period	T _{MN} mm	60	60	60	60	60	60	60
Attraction Force	F _a kN	0	0	0	0	0	0	0
Mechanical Parameters								
Coil Mass (NC)	m _{cn} kg	0.28	0.56	0.56	0.89	0.89	1.19	1.19
Coil Length (NC)	L _{cn} mm	61.0	121.0	121.0	181.0	181.0	241.0	241.0
Coil Length (AC)	L _{ca} mm	61.0	121.0	121.0	181.0	181.0	241.0	241.0
Coil Length (WC)	L _{cw} mm	61.0	121.0	121.0	181.0	181.0	241.0	241.0
Track Mass Per Meter	m _{trck} kg/m	14.75	14.75	14.75	14.75	14.75	14.75	14.75
Other Information								
Insulation Class	Class B (130°C)							
Protection Grade	IP00							
Compliance with Global Standards	RoHS, CE							
Ambient Temperature	Operation	0°C to 40°C (non-freezing)						
	Storage	-15°C to 70°C (non-freezing)						
Ambient Humidity	Operation	10%RH to 80%RH (non-condensing)						
	Storage	10%RH to 90%RH (non-condensing)						
Recommended Ambience	Indoor (no direct sunlight), No corrosive gas, inflammable gas, oil mist or dust.							

- Measurement is taken at ambient temperature 25°C. Value depends on the thermal environment. Abbreviations: NC=Natural Cooling, AC=Air Cooling, WC=Water Cooling.
- Resistance is measured by DC current with standard 0.5 m cable.
- Inductance is measured by current frequency of 1kHz. The variation range of AUM inductance is ±40% because three phase inductances are different. The value in the catalog is the average between the maximum and minimum values. For each phase, the variation range is ±20%. The contents of datasheet are subject to change without prior notice.

Dimension

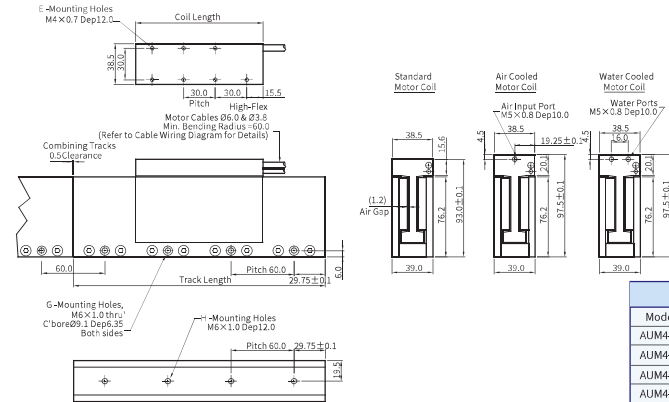

Motor Coil		
Model No.	Coil Length	E
AUM4-S1	61.0	3
AUM4-S2	121.0	7
AUM4-S3	181.0	11
AUM4-S4	241.0	15
AUM4-S5	301.0	19
AUM4-S6	361.0	11
AUM4-S8	481.0	17

For air or water cooled models, Coil Length and E are the same as the standard model. AUM4-S6 Motor Coil, Series 6 and above will use 60mm pitch for E-Mounting Holes.

Motor Track			
Model No.	Track Length	G	H
AUM4-TL120	119.5	2	2
AUM4-TL180	179.5	3	3
AUM4-TL240	239.5	4	4
AUM4-TL300	299.5	5	5
AUM4-TL600	599.5	10	10

Introduction | Sizing Guide | Frequently Asked Questions | Linear Motors | Voice Coil Motors | Direct Drive Rotary Motors | Motion Control of Gantry Stages | Artixis systems

Introduction | Sizing Guide | Frequently Asked Questions | Linear Motors | Voice Coil Motors | Direct Drive Rotary Motors | Motion Control of Gantry Stages | Artixis systems

Force-Speed Curve

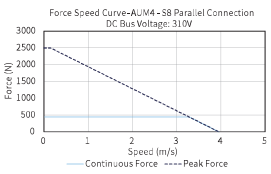
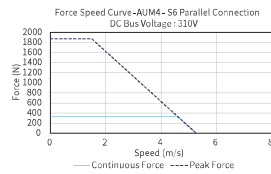
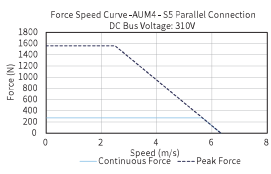
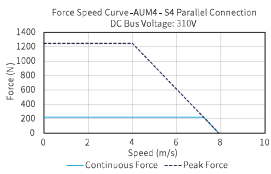
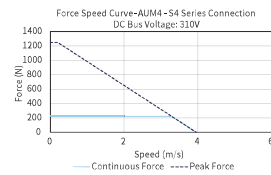
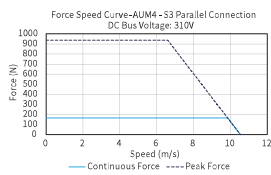
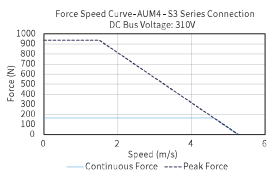
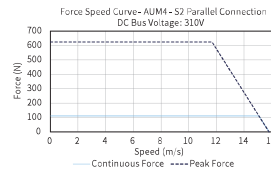
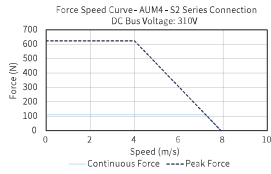
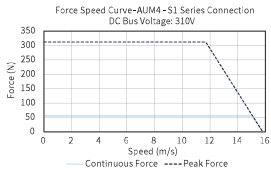

Part Numbering

Motor Coil

AUM4-S-S3-K-HF-0.5-FB

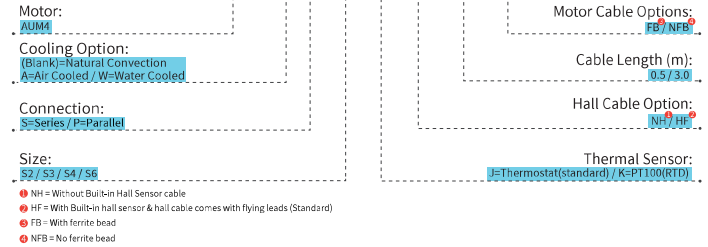

Motor Track

AUM4-TL120



AUM5

			AUM5-S1	AUM5-S2	AUM5-S3	AUM5-S4	AUM5-S5	AUM5-S6	AUM5-S8 -V107	AUM5-S9 -V80	AUM5-S10 -V107	AUM5-S12 -V107		
Performance Parameters														
Continuous Force (NC) @100°C	F _{cn}	N	98	197	197	295	295	393	393	491	590	786	884	983
Continuous Force (AC) @100°C	F _{ca}	N	118	236	236	354	354	472	472	590	707	943	1061	1180
Continuous Force (WC) @100°C	F _{cw}	N	128	255	255	383	383	511	511	639	766	1022	1150	1278
Peak Force	F _{pk}	N	707	1415	1415	2122	2122	2830	2830	3537	4244	5659	6367	7078
Force Constant ±10%	K _f	N/Arms	39.3	78.6	39.3	117.9	59.0	157.2	78.6	117.9	78.6	117.9	98.3	117.9
Back EMF Constant ±10%	K _{emf}	V/(mm/s)	32.1	64.2	32.1	96.3	48.1	128.4	64.2	96.3	64.2	96.3	80.3	96.3
Motor Constant @25°C	K _{tm}	N/Sqr(W)	16.0	22.4	21.9	27.3	27.9	31.5	32.0	35.6	38.9	46.3	48.0	51.3
Resistance (L-L) @25°C ±10%	R ₂₅	Ω	4.02	8.22	2.15	12.42	2.97	16.62	4.02	5.07	6.12	1.92	4.02	2.45
Inductance (L-L) ±40%	L	mH	6.50	13.00	3.25	19.50	4.88	26.00	6.50	8.13	9.75	3.25	6.50	4.06
Electrical Time Constant	τ _e	ms	1.62	1.58	1.51	1.57	1.64	1.56	6.50	1.60	1.59	1.69	1.62	1.66
Continuous Current (NC) @100°C	I _{cn}	Arms	2.5	2.5	5.0	2.5	5.0	2.5	5.0	5.0	10.0	7.5	10.0	10.0
Continuous Current (AC) @100°C	I _{ca}	Arms	3.0	3.0	6.0	3.0	6.0	3.0	6.0	6.0	12.0	9.0	12.0	12.0
Continuous Current (WC) @100°C	I _{cw}	Arms	3.3	3.3	6.5	3.3	6.5	3.3	6.5	6.5	13.0	9.8	13.0	13.0
Peak Current	I _{pk}	Arms	18.0	18.0	36.0	18.0	36.0	18.0	36.0	36.0	72.0	54.0	72.0	72.0
Continuous Power Dissipation (NC) @100°C	P _{cn}	W	49	99	104	150	144	201	194	245	296	372	437	474
Continuous Power Dissipation (AC) @100°C	P _{ca}	W	70	143	150	216	207	289	280	353	426	535	630	683
Continuous Power Dissipation (WC) @100°C	P _{cw}	W	82	168	176	254	243	339	328	414	500	628	739	801
Max. Coil Temperature	T _{max}	°C	100	100	100	100	100	100	100	100	100	100	100	100
Thermal Dissipation Constant (NC)	K _{thn}	W/°C	0.6	1.3	1.4	2.0	1.9	2.7	2.6	3.3	3.9	5.0	5.8	6.3
Thermal Dissipation Constant (AC)	K _{tha}	W/°C	0.9	1.9	2.0	2.9	2.8	3.9	3.7	4.7	5.7	7.1	8.4	9.1
Thermal Dissipation Constant (WC)	K _{thw}	W/°C	1.1	2.2	2.3	3.4	3.2	4.5	4.4	5.5	6.7	8.4	9.9	10.7
Max. Bus Voltage	U _{bus}	Vdc	330	330	330	330	330	330	330	330	330	330	330	330
Magnetic Period	T _M	mm	84	84	84	84	84	84	84	84	84	84	84	84
Attraction Force	F _A	N	0	0	0	0	0	0	0	0	0	0	0	0

Mechanical Parameters														
Coil Mass (NC)	m _{cn}	kg	0.73	1.45	1.45	2.16	2.16	2.88	2.88	3.60	4.32	5.73	6.53	7.25
Coil Length (NC)	L _{cn}	mm	61.0	121.0	121.0	181.0	181.0	241.0	241.0	301.0	361.0	481.0	757.0	841.0
Coil Length (AC)	L _{ca}	mm	61.0	121.0	121.0	181.0	181.0	241.0	241.0	301.0	361.0	481.0	757.0	841.0
Coil Length (WC)	L _{cw}	mm	61.0	121.0	121.0	181.0	181.0	241.0	241.0	301.0	361.0	481.0	757.0	841.0
Track Mass Per Meter	m _{track}	kg/m	25.36	25.36	25.36	25.36	25.36	25.36	25.36	25.36	25.36	25.36	25.36	25.36

Other Information		Class B (130°C)										
Insulation Class		IP00										
Protection Grade		RH=5, CE										
Compliance with Global Standards		RoHS, CE										
Ambient Temperature	Operation	0°C to 40°C (non-freezing)										
	Storage	-15°C to 70°C (non-freezing)										
Ambient Humidity	Operation	10%RH to 80%RH (non-condensing)										
	Storage	10%RH to 90%RH (non-condensing)										
Recommended Ambience		Indoor (no direct sunlight); No corrosive gas, inflammable gas, oil mist or dust.										

- Measurement is taken at ambient temperature 25°C. Value depends on the thermal environment. Abbreviations: NC-Natural Cooling, AC-Air Cooling, WC-Water Cooling.
- Resistance is measured by DC current with standard 0.5m cable.
- Inductance is measured by current frequency of 1 kHz. The variation range of AUM inductance is ±40% because three phase inductances are different. The value in the catalog is the average between the maximum and minimum values. For each phase, the variation range is ±20%. The contents of datasheet are subject to change without prior notice.

Dimension

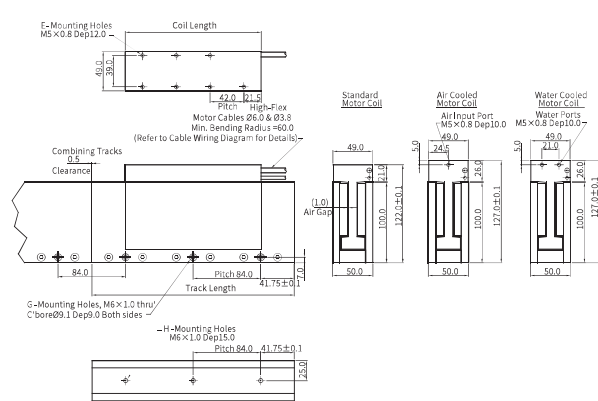

Motor Coil		
Model No.	Coil Length	E
AUM5-S2	169.0	7
AUM5-S3	253.0	11
AUM5-S4	337.0	15
AUM5-S5	421.0	19
AUM5-S6	505.0	23
AUM5-P5-S8-V107	673.0	8
AUM5-P7-S9-V80	757.0	9
AUM5-P5-S10-V107	841.0	10
AUM5-P5-S12-V107	1009.0	12

For air or water cooled models, Coil Length and E are the same as the standard model.

Motor Track			
Model No.	Track Length	G	H
AUM5-TL168	167.5	2	2
AUM5-TL252	251.5	3	3
AUM5-TL420	419.5	5	5

Force-Speed Curve

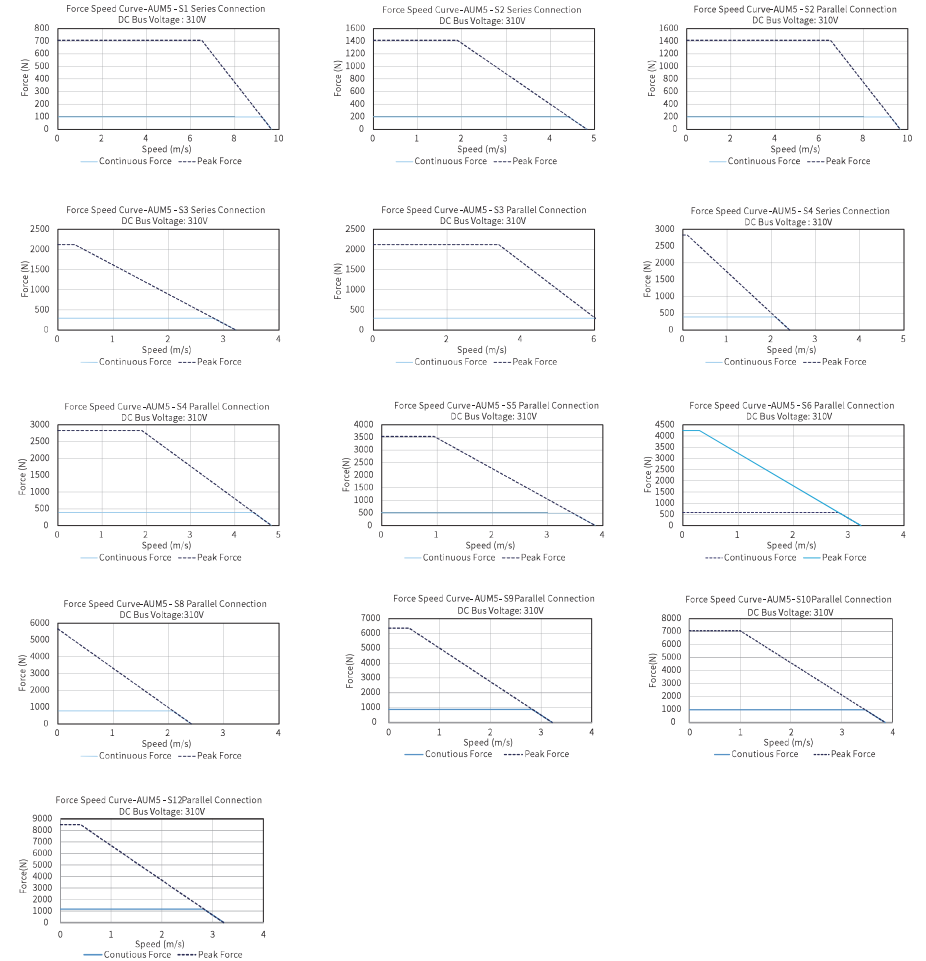

Part Numbering

Motor Coil

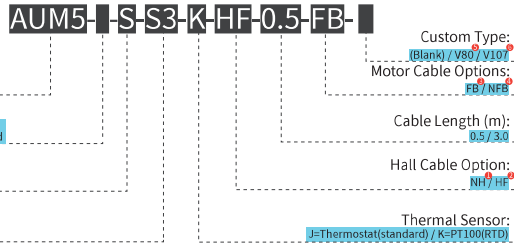

- NH = Without Built-in Hall Sensor cable
- HF = With Built-in hall sensor & hall cable comes with flying leads (Standard)
- FB = With ferrite bead
- NFB = No ferrite bead
- V80 = Only for AUM5-S8 and AUM5-S9
- V107 = Only for AUM5-S10 & AUM5-S12

Motor Track



AUM6

		AUM6-P5-S4	AUM6-P8-S6	AUM6-P5-S8	AUM6-P8-S9	AUM6-P7-S10	AUM6-P8-S12
Performance Parameters							
Continuous Force (NC) @100°C	F _{cn}	N	780	1170	1560	1755	1950
Peak Force	F _{pk}	N	5400	8100	10800	12150	13500
Force Constant ±10%	K _f	N/Arms	75.0	75.0	150.0	112.5	150.0
Back EMF Constant ±10%	K _e	Vpeak/(m/s)	61.2	61.2	122.5	91.9	122.5
Motor Constant @25°C	K _m	N/Sqrt(W)	53.3	67.5	72.9	79.9	82.2
Resistance (L-L) @25°C ±10%	R ₂₅	Ω	1.32	0.82	2.82	1.32	2.22
Inductance (L-L) ±40%	L	mH	2.65	1.77	5.30	2.65	4.24
Electrical Time Constant	τ _e	ms	2.00	2.15	1.88	2.00	1.91
Continuous Current (NC) @100°C	I _{cn}	Arms	10.4	15.6	10.4	15.6	13.0
Peak Current	I _{pk}	Arms	72.0	108.0	72.0	108.0	90.0
Continuous Power Dissipation (NC) @100°C	P ₂₅	W	276	387	500	622	726
Max. Coil Temperature	T _{max}	°C	100	100	100	100	100
Thermal Dissipation Constant (NC)	K _{th}	W/°C	3.7	5.2	7.9	8.3	9.7
Max. Bus Voltage	U _{bus}	Vdc	330	330	330	330	330
Magnetic Period	T _{0.5}	mm	84	84	84	84	84
Attraction Force	F _a	kN	0	0	0	0	0
Mechanical Parameters							
Coil Mass (NC)	m _{cn}	kg	4.50	6.75	9.00	10.13	11.25
Coil Length (NC)	L _{cn}	mm	337.0	505.0	673.0	757.0	841.0
Track Mass Per Meter	m _{track}	kg/m	66.67	66.67	66.67	66.67	66.67
Other Information							
Insulation Class	Class B (130°C)						
Protection Grade	IP00						
Compliance with Global Standards	RoHS, CE						
Ambient Temperature	Operation	0°C to 40°C (non-freezing)					
	Storage	-15°C to 70°C (non-freezing)					
Ambient Humidity	Operation	10%RH to 90%RH (non-condensing)					
	Storage	10%RH to 90%RH (non-condensing)					
Recommended Ambience	Indoor (no direct sunlight); No corrosive gas, inflammable gas, oil mist or dust.						

- Measurement is taken at ambient temperature 25°C. Value depends on the thermal environment. Abbreviations: NC=Natural Cooling, AC=Air Cooling, WC=Water Cooling.
- Resistance is measured by DC current with standard 0.5 m cable.
- Inductance is measured by current frequency of 1 kHz. The variation range of AUM inductance is ±40% because three phase inductances are different. The value in the catalog is the average between the maximum and minimum values. For each phase, the variation range is ±20%. The contents of datasheet are subject to change without prior notice.

Dimension

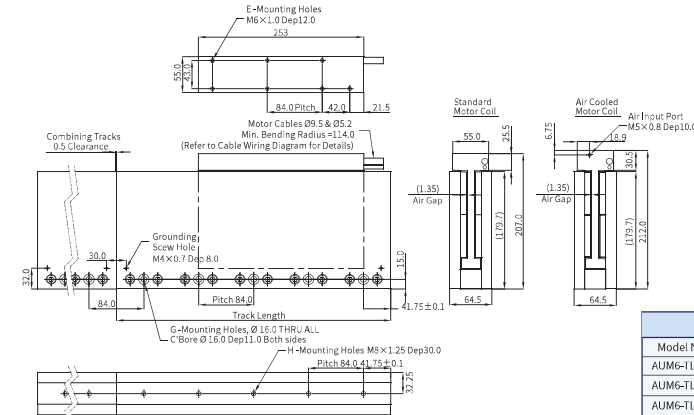

Motor Coil		
Model No.	Coil Length	E
AUM6-P5-S4	337.0	9
AUM6-P8-S6	505.0	13
AUM6-P5-S8	673.0	17
AUM6-P8-S9	757.0	19
AUM6-P7-S10	841.0	21
AUM6-P8-S12	1009.0	25

Motor Track			
Model No.	Track Length	G	H
AUM6-TL168	167.5	2	2
AUM6-TL252	251.5	3	3
AUM6-TL420	419.5	5	5

Force-Speed Curve

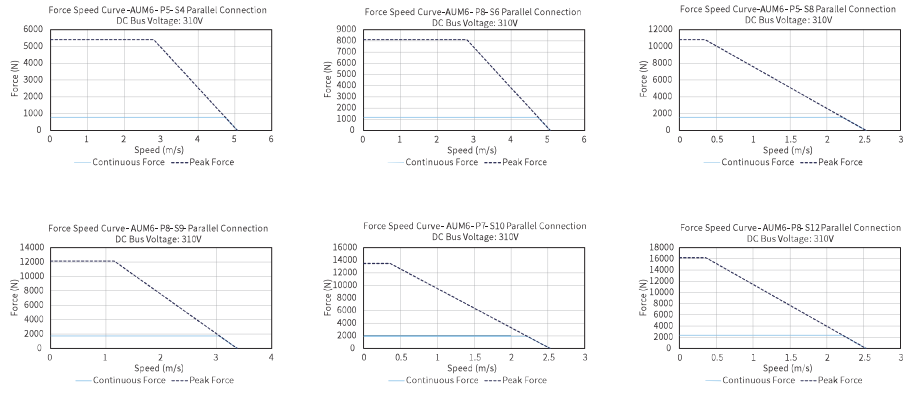

AUM1 Series Motor Cable Connection

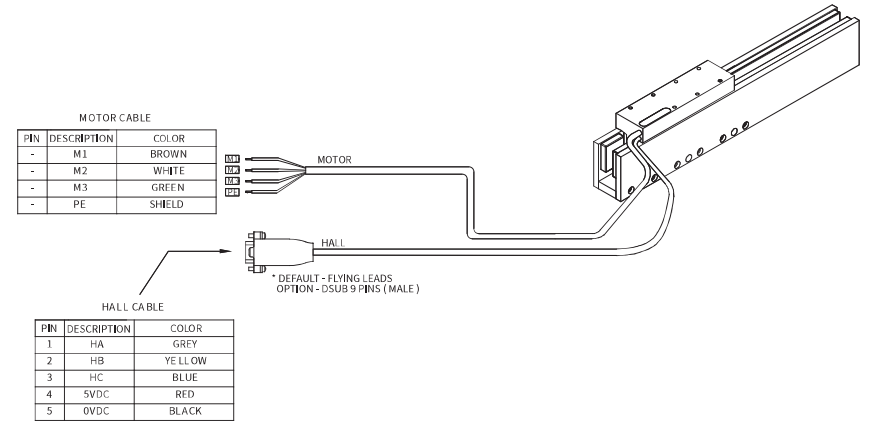

Part Numbering

Motor Coil

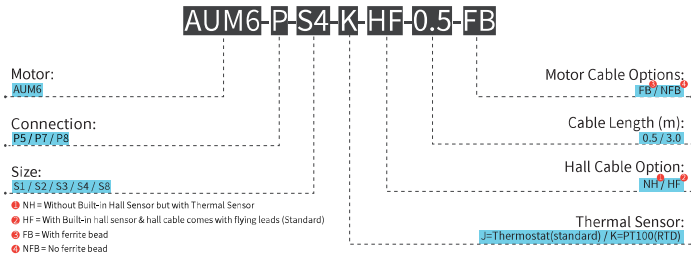

Motor Track

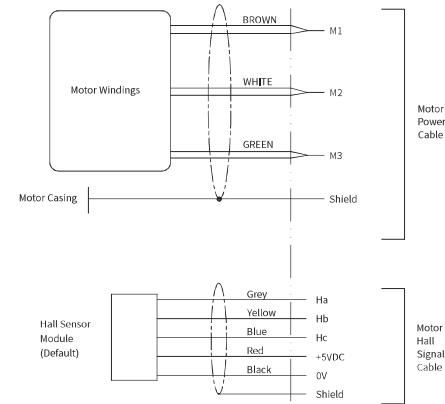
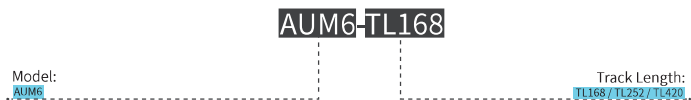

Introduction | Sizing Guide | Frequently Asked Questions | Linear Motors | Voice Coil Motors | Direct Drive Rotary Motors | Motion Control of Gantry Stages | Akribis systems

Introduction | Sizing Guide | Frequently Asked Questions | Linear Motors | Voice Coil Motors | Direct Drive Rotary Motors | Motion Control of Gantry Stages | Akribis systems

AUM2 / 3 / 4 / 5 Series Motor Cable Connection

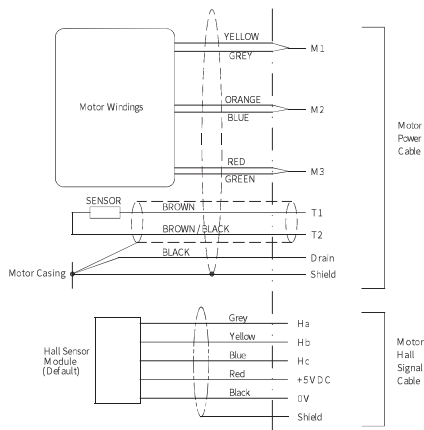
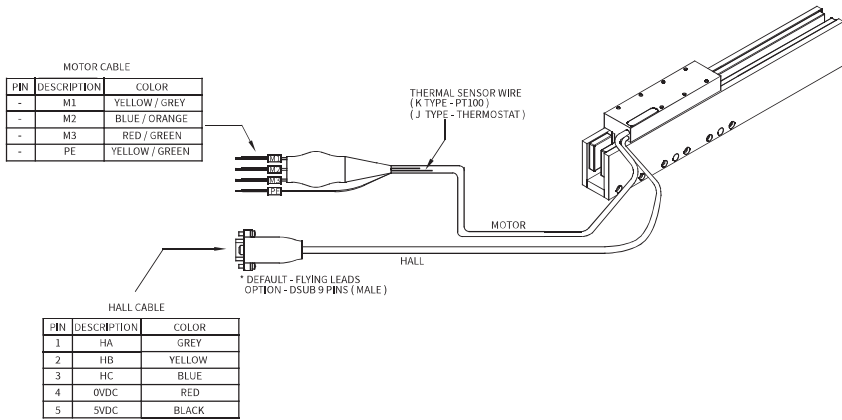

AUM6 Series Motor Cable Connection

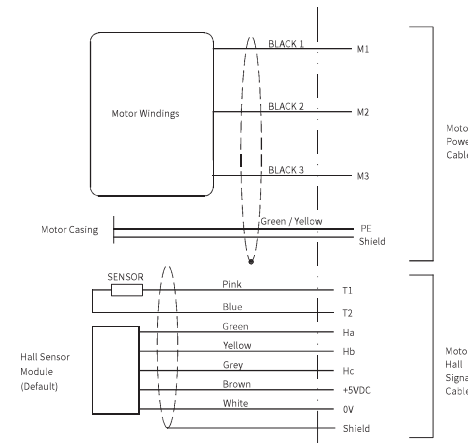
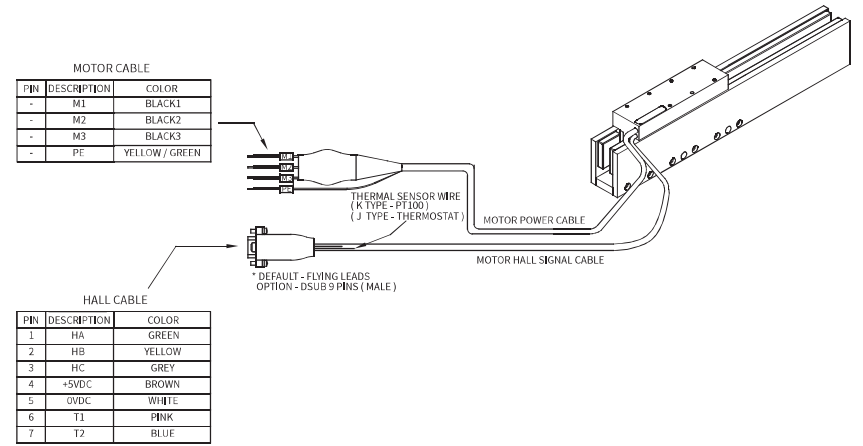

Introduction | Sizing Guide | Frequently Asked Questions | Linear Motors | Voice Coil Motors | Direct Drive Rotary Motors | Motion Control of Gantry Stages | Akrasis systems

Introduction | Sizing Guide | Frequently Asked Questions | Linear Motors | Voice Coil Motors | Direct Drive Rotary Motors | Motion Control of Gantry Stages | Akrasis systems